

OT 18 FK 800 N3

Diffuse Sensor

- Universal mounting possibility
- Low installation depth
- Sensitivity adjustable
- LED indicator for output state
- Plastic housing

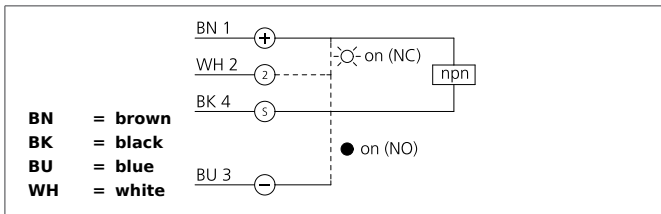

Safety instructions

The Instruments are not to be used for safety applications, in particular applications in which safety of persons depends on proper operation of the instruments.
 These instruments shall exclusively be used by qualified personnel.

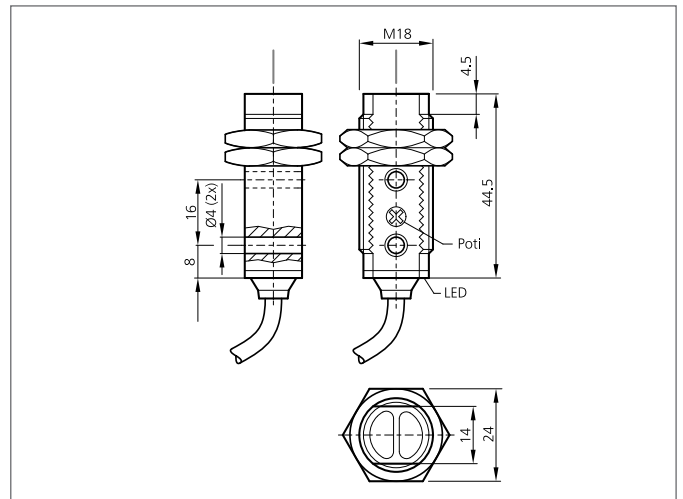

TECHNICAL INFORMATION (typ.)	+20°C, 24V DC
Operating principle	Diffuse reflective sensor
Evaluation	digital
Size	M18 x 1 (thread)
Design	screw
Emitted light	Infrared, 880 nm, clocked
Standardized measuring plate	200 x 200 mm
Service voltage	10 ... 30 V DC
Internal power consumption	30 mA
background suppression	no
Operating distance	800 mm
Sensitivity adjustment	potentiometer
Switching output	npn, 100 mA, NO/NC
Switching frequency	1.000 Hz
Response-/release time	0,5 ms / < 0,5 ms
Ambient temperature	-25 ... +55 °C
Ambient light immunity	3 kLx, clocked light, > 10 kLx, Sunlight
Protection class	IP 67
Protection degree	III, operation on protective low voltage
Casing material	ABS
Material	polymethyl methacrylate (Window)
Connection	cable PVC, 2 m